

Article number: 5798011503

Description: Tsubaki Cam clutch bearing BB15-2K-K (6202)
d=15 D=35 T=11, with keyway on inner & outer race steel sealed

Measures

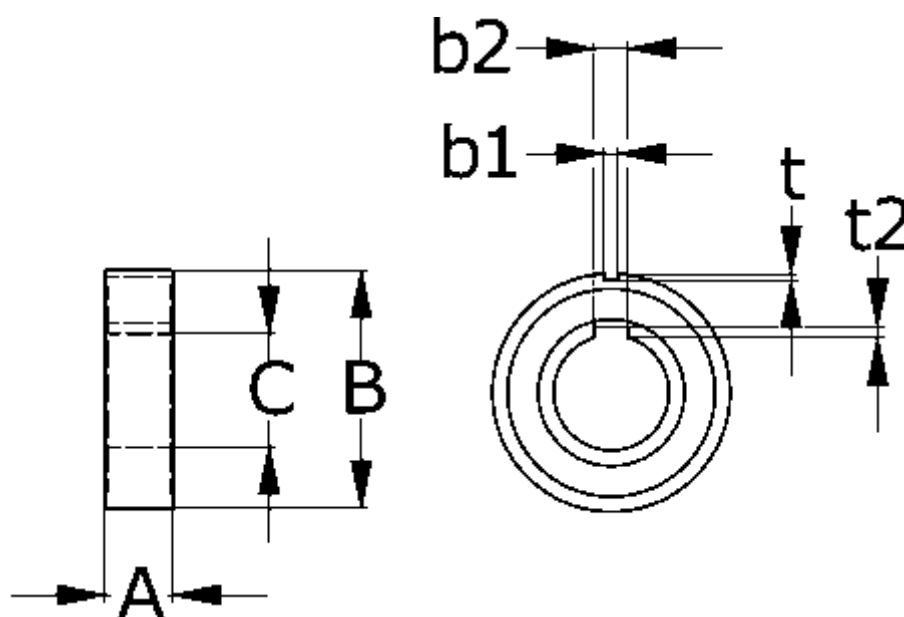

A	= 11
B	= 35
b1	= 2
b2	= 5
C	= 15
t1	= 0.6
t2	= 1.2
Torque (Nm)	= 29